

COPAL ELECTRONICS

SMALL SIZE PRESSURE GAUGE **PG-75**

CE marking
(Compliance with EMC Standards)

Instruction Manual
Ver.1.3

Thank you for purchasing a
NIDEC COPAL ELECTRONICS CORP. product.
In order to use the product correctly and most
appropriately, please completely read this manual before
use and keep it for future reference.

For more information please contact:

COPAL ELECTRONICS

NIDEC COPAL ELECTRONICS CORPORATION
Nishi-Shinjuku Kimuraya Bldg., 7-5-25
Nishi-Shinjuku Shinjuku-ku Tokyo 160-0023, Japan Phone: (03) 3364-7055

Important Information and Warnings



This caution mark describes when there is a possibility that user may suffer from injury or physical damage if the product is used improperly.

★Please perform the zero point adjustment to PG-75 after the warm-up of about 30 minutes or more.

- ① The applicable pressure medium of PG-75 are gases and liquids that are compatible with SUS304 and SUS316L.
- ② For stability, use a regulated direct current power supply. When you use the switching power supply, the FG terminal FG should be earthed.
- ③ Surge absorbing devices (diodes, varistors, etc.) are necessary if inductive loads such as relays or solenoids are connected to the same circuit as PG-75.
- ④ Turn off the power when any wiring is done. Also, do not mis-wire.
- ⑤ Do not wire parallel to high tension cables or power lines, or use cable ducts containing high tension cables or power lines.
- ⑥ Be careful not to put any pressure on the display area of the main body while performing piping work.
- ⑦ If liquids such as water, oil, etc may splash to the main body and it may flow into the inside of the product through the air intake, connect the silicon tube (2.5×4) to the air intake and place the tube so that the other end of the tube will not be splashed with the liquid. At that time, do not bend the tube or block the other end.
- ⑧ Use pH neutral detergents to clean the body. Do not use solvents such as thinners.
- ⑨ This product is dustproof and splashproof (Equal to IEC IP65), and is not designed for using in the water-proof environment or for outdoor use.
- ⑩ Do not use pointed objects such as pens to press the setting buttons on the display panel, as this may make holes in the setting buttons and damage them.
- ⑪ Do not insert foreign objects such as wires to the pressure port as this may damage the diaphragm and disrupt normal operations.
- ⑫ This product does not have an explosion proof structure. Do not use this product in an atmosphere that contains flammable gases.
- ⑬ Use a low-pass filter in your circuit as the analog output of the PG-75 contains noise elements of the internal switching power supply.
- ⑭ Due to the lightning surge capacity of the product, this product cannot be installed outdoors and/or be installed with an extension cable 30m or longer.
- ⑮ Operating Precautions for UL Recognition Product : Maximum surrounding air temperature is 50°C.
- ⑯ Please use power supplies of class 2 complying with the UL standard for DC power.

Specifications

Spec item	Mode Pressure Range	PG-75					
		102G	103G	353G	102R	103R	353R
Type		Gauge pressure			Gauge pressure (Compound)		
Rated pressure range	Pr(L)~Pr(H)	0~100kPa	0~1.0MPa	0~3.5MPa	-100~100kPa	-0.1~1.0MPa	-0.1~3.5MPa
Maximum pressure	Pmax	200kPa	2MPa	5MPa	200kPa	2MPa	5MPa
Break-down pressure	Pb	300kPa	3MPa	7MPa	300kPa	3MPa	7MPa
Full-scale	FS	100kPa	1MPa	3.5MPa	200kPa	1.1MPa	3.6MPa
Acceptable medium		Liquids and Gases compatible with SUS304 and SUS316L					
Enclosed liquid		Silicone oil					
Operating voltage	Vopr	10.8~30VDC / including ripple					
Current consumption		50mA maximum / All lights are on. No load on sw output and not including analog output currents.					
Switch output	Number of outputs	Two outputs (NPN/PNP)					
	Switching capacity	30VDC / 100mA maximum					
	Residual voltage	1.2V maximum (NPN) / 2.2V maximum (PNP), Load current 100mA					
	Hysteresis	0~Approx 30 %FS					
	Repeatability	±0.3 %FS / Reference temp. 25°C					
	Accuracy	±2%FS / Including errors of setting, linearity, hysteresis and thermal error.					
	Response	Approx 2.5, 25, 250, 1000, 2000 ms / 2.5ms is set prior to delivery					
	Protection	Exists / Short circuit protection					
	Operation display	During output is on. / Light up the LED. The Opposite color to the color for pressure display.					
Analog output	Voltage output	Vo	1~5V / Pr(L)~Pr(H), FS : 4V				
		Accuracy	±2%FS / Including errors of setting, linearity, hysteresis and thermal error. (Measurement load resistance : 1M Ω or more)				
		Resolution	Approx 2.7mA : 0.07%FS				
		Output resistance	Approx 1k Ω (Internal impedance)				
		Response	Approx 2ms maximum				
		Current output	Io	4~20mA / Pr(L)~Pr(H), FS : 16mA			
Accuracy	±2%FS / Including errors of setting, linearity, hysteresis and thermal error. (Measurement load resistance: 250 Ω)						
Resolution	Approx 0.011mA : 0.07%FS						
Load resistance	Vopr≤18VDC : 50~300Ω, Vopr>18VDC : 50~500Ω						
Response	Approx 2ms maximum						
Pressure display	Display methode	3+1/2 digits, Red and Green 7 segment LED (Height:10mm) Reverse display selectable in tandem with SW1.					
	Display cycle	5 times /sec (moving average)					
	Accuracy	±2%FS / Including errors of setting, linearity, hysteresis and thermal error.					
Environmental characteristics	IP protection	IP65 of IEC					
	Operating temp.	-10~50°C (Storage Temperature : -20~70°C)					
	Operating humidity	35~85%RH					
	Insulation resistance	100MΩ minimum at DC500V between bundled leads and pressure port					
	Dielectric strength	One minuts at AC500V between bundled leads and pressure port (1mA maximum leakage)					
	Vibration	10~500Hz 1.5mm maximum / 98.1m/s ² , three directions, two hours each					
	Shock	490m/s ² , three directions, three times each					
	EMC	EMI : EN55011:2009, A1:2010 Group 1, Class B EMS : EN61326-1:2006 Table 2, EN61326-2-3:2006 AnnexBB					
Fitting port types	R1 (R1/8), R2 (R1/4)						
Fitting materials	Diaphragm(SUS316L),Fitting(SUS304)						
Net Weight	Approx. 115±15g (incl. 2m cable)						
Accessories	Nothing						

Output Electrical Schematics (Example: PG-75-102R-xxR2)

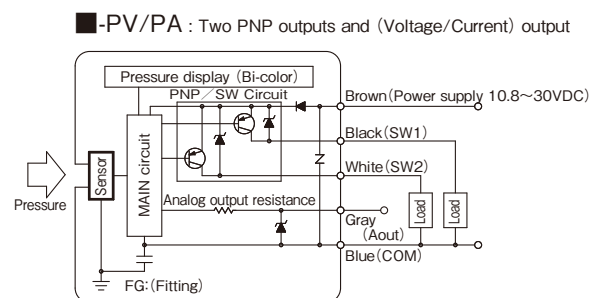
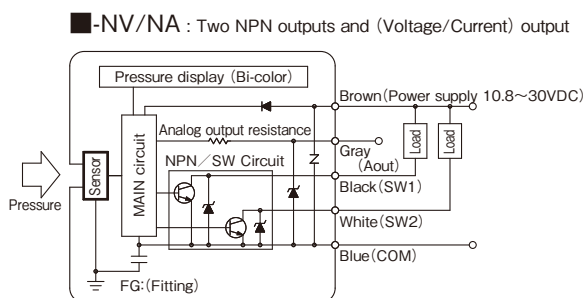

Panel Function

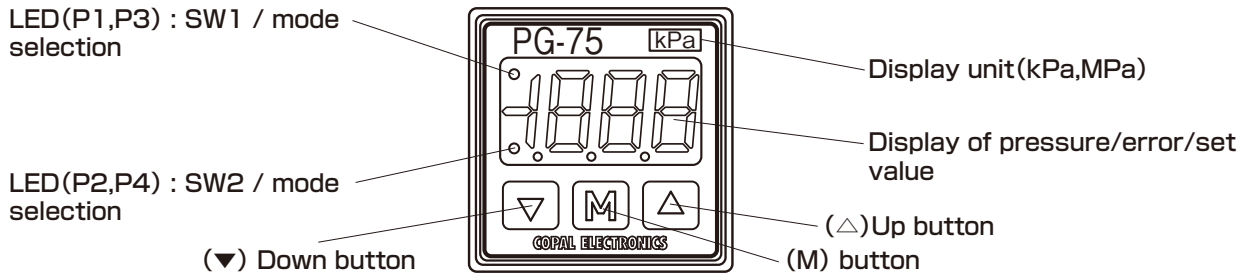

Operating Procedure

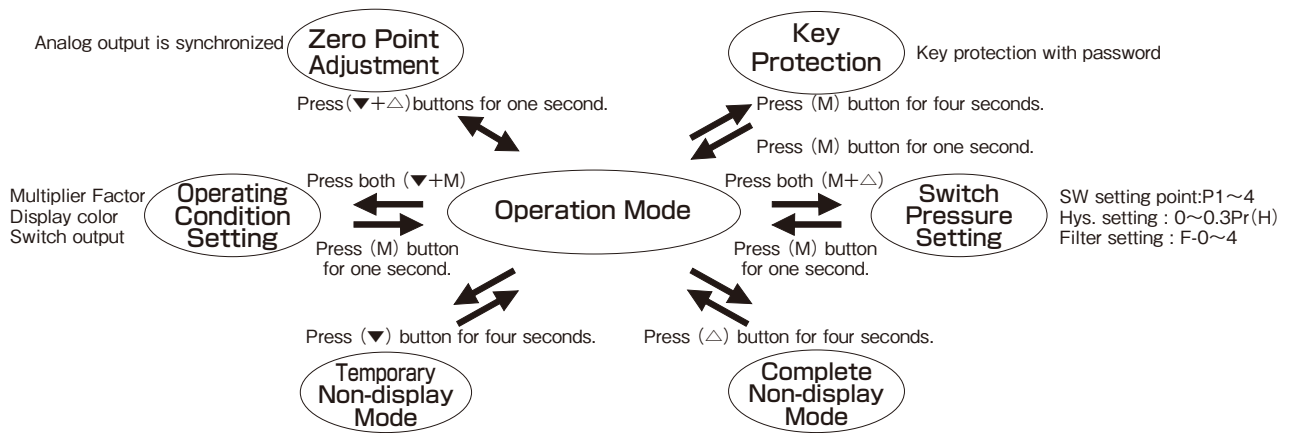

Operating Condition Setting

■ Setting operating conditions

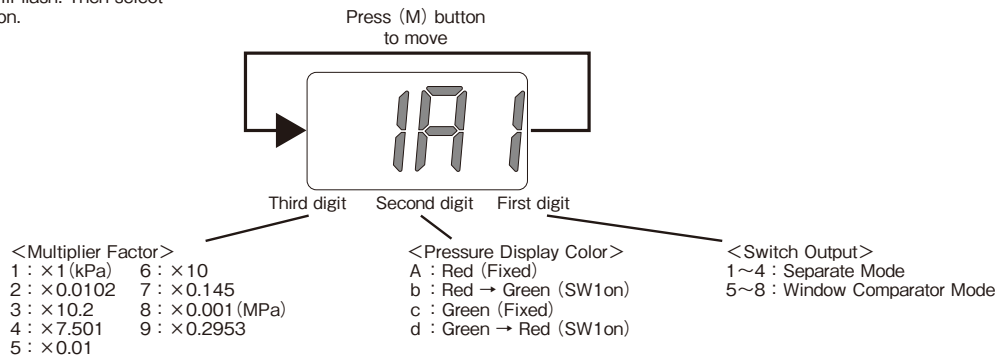
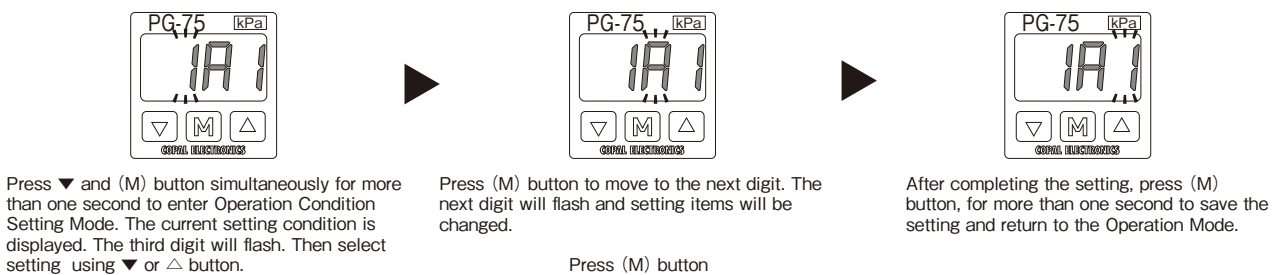

Multiplier Factor

■ The multiplier factor is selectable by changing the value of third digit on the display during the operation setting.

Multiplier Factor	Pressure Range (-Pr ~ + Pr)					
	102G	102R	103G	103R	353G	353R
1:×1 (kPa)	0.0 ~ 100.0	-100.0 ~ 100.0	0 ~ 1000	-100 ~ 1000	-	-
2:×0.0102	.000 ~ 1.020	-1.020 ~ 1.020	0.00 ~ 10.20	-1.02 ~ 10.20	0.0 ~ 35.7	-1.0 ~ 35.7
3:×10.2	0 ~ 1020	-1020 ~ 1020	-	-	-	-
4:×7.501	0 ~ 750	-750 ~ 750	-	-	-	-
5:×0.01	.000 ~ 1.000	-1.000 ~ 1.000	0.00 ~ 10.00	-1.00 ~ 10.00	0.0 ~ 35.0	-1.0 ~ 35.0
6:×10	0 ~ 1000	-1000 ~ 1000	-	-	-	-
7:×0.145	0.0 ~ 14.5	-14.5 ~ 14.5	0.0 ~ 145.0	-14.5 ~ 145.0	0 ~ 508	-15 ~ 508
8:×0.001 (MPa)	-	-	.000 ~ 1.000	-100 ~ 1.000	0.00 ~ 3.50	-0.10 ~ 3.50
9:×0.2953	0.0 ~ 29.5	-29.5 ~ 29.5	0 ~ 295	-30 ~ 295	0 ~ 1033	-30 ~ 1033

- The settings indicated by "-" on the table above are not selectable because of resolution.
- Either "1" (for 102G, and 102R) or "8" (for 103G, 103R, 353G and 353R) are set prior to delivery.
- Changes of the multiplier factor apply to display values. Also, note the changes reset switch setting value and hysteresis.

Display Color

■ The display color is selectable by changing the value of second digit on the display during the operation setting.

SW1	ON	OFF	ON
SW2	OFF	ON	OFF

Code	Change of Display Color		
A	Red		
b	Green	Red	Green
c	Green		
d	Red	Green	Red

- The change of display color applies to SW1 operation only.
- The factory setting is "A" (Always red)
- Values other than pressure value (SW monitor, setting display, error messages etc) are displayed in opposite color of the pressure value (Red/Green).

Switch Output

■ SW output is selectable by changing the value of first digit on the display.

Output Mode	<SW Operation Code>				<Switch Operation Mode>			
	SW1		SW2		Separate Mode		Window Comparator Mode	
Operation	HI	LO	A	B	HI	LO	A	B
1	○				○			
2	○					○		
3		○					○	
4		○						○
5			○				○	
6			○					○
7				○			○	
8				○				○
Pressure setting	Set 1		(Minimum) Set 1 (Maximum) Set 3		Set 2		(Minimum) Set 2 (Maximum) Set 4	

Separate Mode	Window Comparator Mode
(HI operation) 	(A operation)
(LO operation) 	(B operation)
$P1 \leq P2$ or $P1 \geq P2$	$P1 \leq P3-2H$ and $P2 \leq P4-2H$

H:Hysteresis, P1=Set 1, P2=Set 2, P3=Set 3, P4=Set 4

- In the Separate mode, SW 1 corresponds to Setting 1 and SW2 corresponds to Setting 2.
- In the Window Comparator Mode, SW 1 corresponds to the Setting 1 (lower limit) and Setting 3 (upper limit). Also, SW2 corresponds to the setting 2 (lower limit) and setting 4 (upper limit).
- The Hysteresis (H) setting is common to SW 1 and SW 2 operations.
- When SW operation is changed between the Separate Mode and Window Comparator Mode, SW pressure settings that are set separately will be reset.

Switch Pressure Setting

■ This mode is for setting SW setting value, Hysteresis, and Digital filter. To return to the operation mode during the setting, press (M) button more than one second. The setting will be saved.

When the setting of either the multiplier factor or switch operation mode is changed, the setting of switch pressure will be reset.

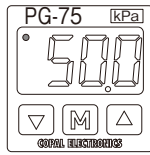

During the Operation Mode, press (M) and Δ buttons for more than one second to enter SW Pressure Setting Mode. The SW1 LED flashes. The display color will be reversed and the current SW1 setting value will be displayed. Set the switch value using ∇ and Δ buttons. SW pressure setting range : -110kPa or -0.11Pr (H) $\sim 1.1\text{Pr (H)}$ (whichever range is narrower).

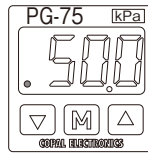

Press (M) button once. The SW2 LED will flash. The current SW2 setting value will be displayed. Set the switch value using ∇ and Δ buttons.

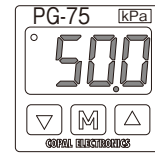

(Only when the Window Comparator Mode is set) Press (M) button once. The display color will be reversed and the SW1 LED will flash and the current value of P3 will be displayed. Set the P3 value in the same manner. Note P3 and P4 setting ranges are influenced by Hysteresis (H). See Switch Operation Mode table for the details.

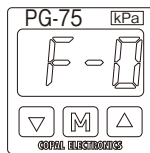

Press (M) button once. Both SW1 and SW2 LEDs will turn off and the Digital filter setting will be displayed. Set the value in the same manner. Response time : (F-0, 1, 2, 3, 4) : (2.5, 25, 250, 1000, 2000)ms F-0 (2.5ms) is set prior to delivery.

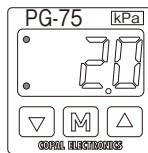

Press (M) button once. The display color will get back to the original color and both SW1 and SW2 LEDs will flash. The current Hysteresis (H) value will be displayed. Set the value using ∇ and Δ buttons. Hysteresis setting range : $0 \sim$ approximately 0.3Pr (H) .

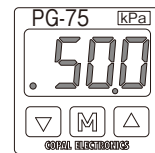

(Only when the Window Comparator Mode is set) Press (M) button once again. The SW2 LED will flash and the current value of P4 will be displayed. Set the P4 value in the same manner.

Zero Point Adjustment

■ This function is for adjusting the zero point of pressure display and analog output when the pressure port is opened to the atmosphere.

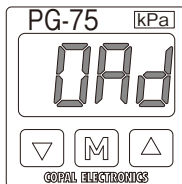

- During the operation mode, press ∇ and Δ buttons simultaneously for more than one second. Display of "0Ad" will blink.
- One second after releasing the ∇ and Δ buttons, the adjustment will be completed.
- If residue pressure remains in the pressure port and the pressure is more than $\pm 10\%$ of rated pressure, zero adjustment will be cancelled and "E-2" error message will be displayed.
- To cancel the error message, press (M) button and release the residue pressure. Then, adjust the zero point once again.

Key Protection

- The Key Protection Mode is used to lock the front panel key in order to prevent setting values from been accidentally changed. Only the cancellation entry can be made. The Key Protection status is saved to the flash memory and maintained even after the power is turned off.

<Key Protection Mode >

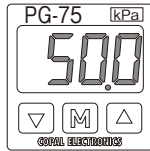

Press Δ button for more than four seconds during the Operation Mode. The display color will be reversed and "00" will be displayed.

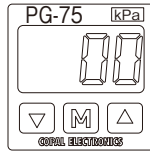

Two-digit numeric secret code is necessary. The code "00" does not require the entry of the code when canceling the protection.

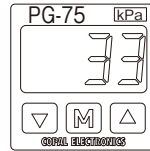

When a number from "01~99" is selected for the secret code, entry of the same code is required to cancel the protection. The code can be selected by ∇ and Δ buttons. To save the code, press (M) button.

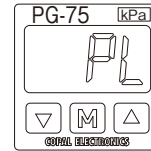

"PL" will be displayed and the key entry will be locked except for cancellation entry.

<Cancellation of Key Protection >

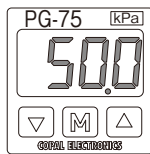

To cancel the protection, press Δ button for more than four seconds. The display color will be reversed and "00" will be displayed.

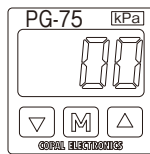

When a code from "01~99" is set, the code entry will be required.

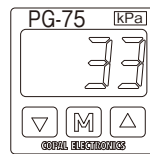

For example, select "33" and press (M) button. If the incorrect code is entered three times, the buttons will be locked again.

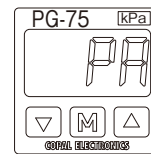

If the code is entered correctly, "PA" will be displayed and the buttons will be unlocked.

Temporary Non-display Mode

- This mode is for temporarily turning off pressure display.
 - When this mode is on, the pressure display automatically will turn off after 10 seconds if not used. When the display is turned off, the decimal LED will blink.
 - If any error is detected during this mode, error message will be displayed. After the error is corrected, the Temporary Non-display Mode will resume.
 - Any key entry for other settings will be accepted in this mode. Even after the display turns on again, this mode will last until it is cancelled.
 - If the Full Time Non-display Mode (as explained later) is set during this Temporary Non-display Mode, the system will be switched to the Full Time Non-display Mode.
 - The setting data of this mode is stored to flash memory and will not be lost even after the power is turned off.

<Setting and Canceling of Temporary Non-display Mode>

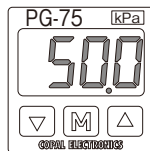

Press ∇ button for more than four seconds during the normal operation.

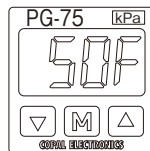

The display color will be reversed and "50F" will be displayed. At this stage, normal pressure display will be displayed

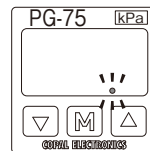

If there is no key operation for more than 10 seconds, the pressure display will go off and the decimal LED will blink.

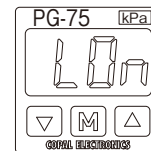

To cancel this mode, Press ∇ button for more than four seconds. The display color will be reversed and "LON" will be displayed. Then the product will get back to the normal operation.

Complete Non-display Mode

■ This mode is for constantly turning off pressure display.

- When this mode is on, the pressure display will be turned off and will not accept any key operation except the cancellation operation. The decimal LED will be on.
- If any error is detected during this mode, error message will be displayed. After the error is corrected, the Complete Non-display Mode will resume.
- Any key entry for other settings will not be accepted during this mode.
- The setting data of this mode is stored to flash memory and will not be lost even after the power is turned off.

<Setting and Canceling of Complete Non-display Mode>

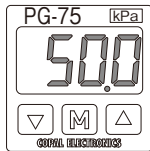

Press (M) button for more than four seconds during the normal operation.

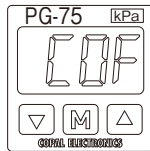

The display color is reversed and "COF" will be displayed. Then, the display will be turned off.

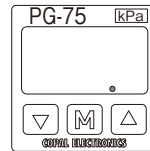

The decimal LED will light.

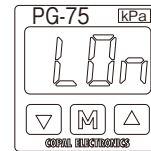

To cancel the mode, press (M) button for more than four seconds. The display color will be reversed and "LOn" will be displayed. Then the product will get back to the normal operation.

Troubleshooting

■ If an error occurs, please refer to the table as below and follow the procedures.

Error Display/Description	Problem	Solution
E1	Current Overloaded on SW. Both SW1 and SW2 are off. (Flashing LED indicates excessive current on SW1 or SW2.)	Turn off the power and check the load connected to SW1 and/or SW2.
E2	Pressure more than +/- 10% of the rated pressure is applied during the zero point adjustment.	Press (M) button to cancel the error display. Release the residue pressure and then make the zero point adjustment again.
Black out of pressure display	During the operation mode, key entry is possible. However, pressure display blacks out and the decimal LED blinks.	It is a normal state and the product is in the Temporary Non-Display Mode. In order to cancel the mode, press ▼ button for more than four seconds.
Black out of pressure display and no key entry possible	Even though the power is on, key entry is not possible. Also, pressure display blacks out and the decimal LED lights.	It is a normal state and the product is in the Full Time Non-Display Mode. In order to cancel the mode, press (M) button for more than four seconds.
No key entry possible	During the operation mode, key entry is not possible even though the pressure value is displayed.	It is a normal state and the product is in the Key Protection Mode. In order to cancel the mode, press △ button for more than four seconds. If the secret code is set, the code entry is necessary.

Externals specification (unit:mm)

■ Vertical installation type

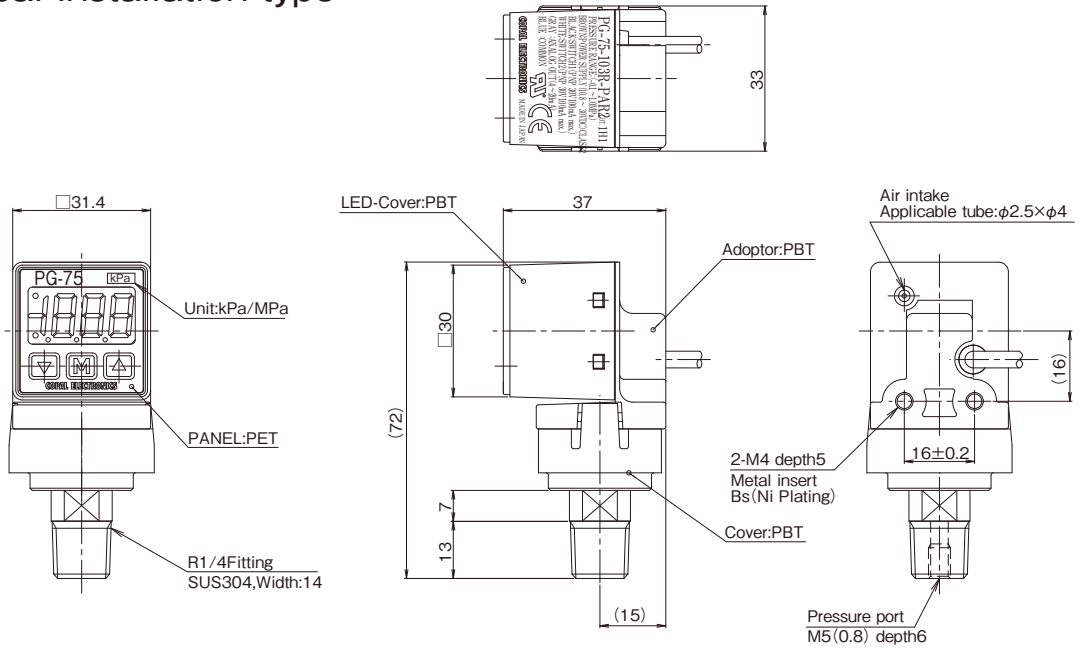

■ The horizontal installation type

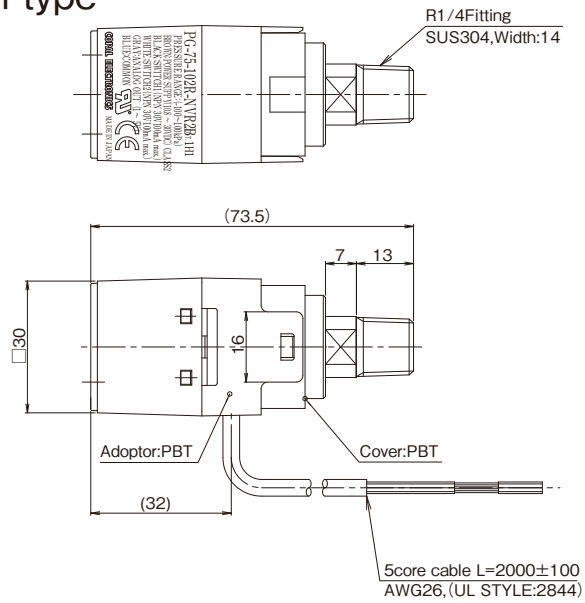

Brackets (Option)

■ Vertical installation type

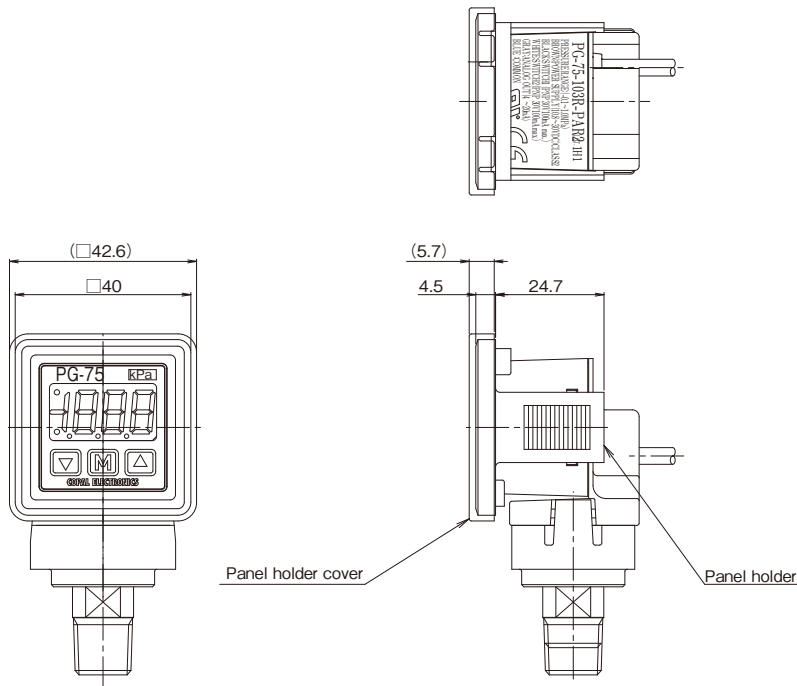

■ The horizontal installation type

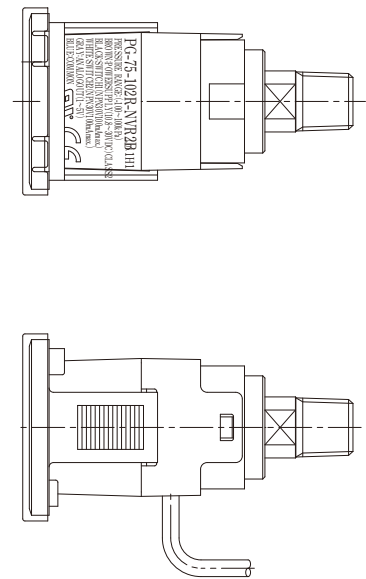

Others

■ Tube at air intake

•If there is a possibility that liquids such as water, oil etc splash to the main body and it may flow into the inside of the product through the air intake, connect a silicon tube to the air intake and position the other end of the tube in a suitable safe place. At that time, do not bend the tube or block the other end of the tube.

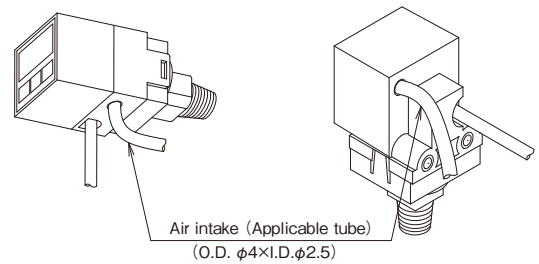

■ Piping

•Use a wrench on the hexagon of the fitting. Do not hold the main body when tightening.

Warranty

•Nidec Copal Electronics warrants the product for the period of one year from customer's receipt. We will repair the defective product caused by our improper designing and/or production at our cost.

Our warranty is limited to the product only and not applicable to other damages caused by the product failure.

However, our warranty is not applicable if the causes of defect should result from the following conditions:

- 1.) Failure or damages caused by inappropriate use or carelessness which are not in accordance with the Instruction Manual.
- 2.) Failure or damages caused by inappropriate modifications, adjustment, or repair.
- 3.) Failure or damages caused by natural disaster, fire or unavoidable factors.

Model Numbers

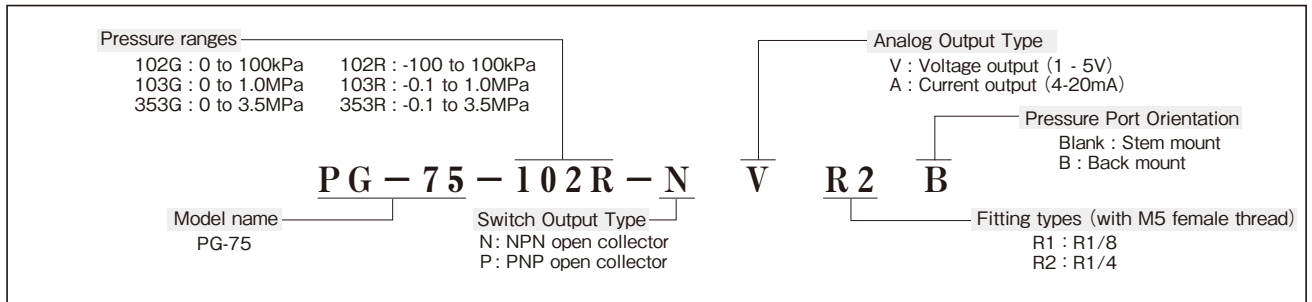

SCIGATE AUTOMATION (S) PTE LTD

No.1 Bukit Batok Street 22 #01-01 Singapore 659592
 Tel: (65) 6561 0488 Fax: (65) 6562 0588
 Email: sales@scigate.com.sg Web: www.scigate.com.sg
 Business Hours: Monday - Friday 8.30am - 6.15pm